

# ThermTec

## Thermal Imaging Scope ARES & ARES LRF SERIES

### User Manual



IOS



Andriod



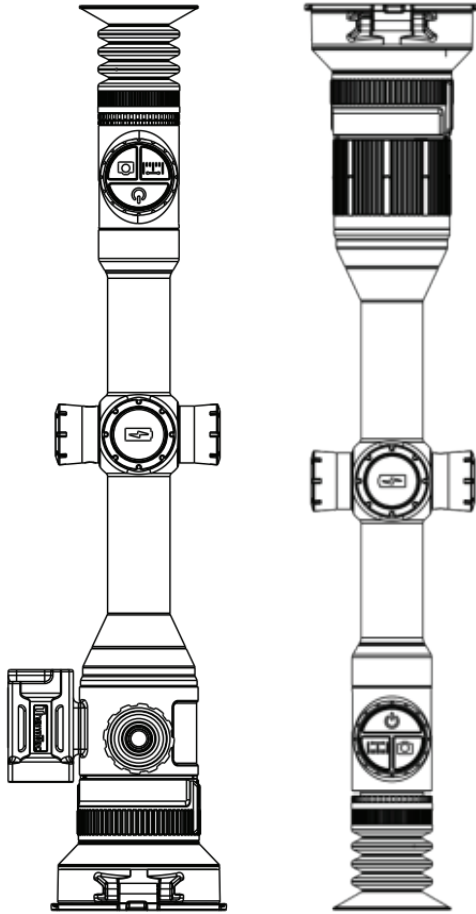

# Table of Contents

About This Manual	5	5.4.2 Objective Lens Focusing	19
Regulatory Information	6	5.4.3 Digital Adjustment of Focus Distance	20
1. Introduction	8	5.4.4 FOV Selection and Shifting	20
1.1 Device Description	8	5.5 Shortcut Menu	20
1.2 Features	9	5.6 Color Plate	23
1.3 Detection Range	10	5.7 Image Settings	24
1.4 Cautions	10	5.8 Settings	25
2. Packing List	11	5.9 Zeroing	28
3. Specifications	13	5.9.1 Automatic Zeroing	29
4. Appearance	15	5.9.2 Manual Zeroing	29
4.1 Dimensions	15	5.10 Image Calibration	31
4.2 Buttons and Controls	16	5.11 Reticles	31
5. Operation Guide	17	5.12 Blind Pixe	32
5.1 Battery Installation	17	5.13 Updates	32
5.2 Power-on the Device	18	6. APP Download	33
5.3 Main Menu	18	7. WIFI and Hotspot Settings	33
5.4 Lens Adjustment	19	7.1 Connect via WIFI	33
5.4.1 Diopter Adjustment	19	7.2 Connect via Hotspot	34

# About This Manual

COPYRIGHT © 2023 ThermTec Technology Co., Ltd. ALL RIGHTS RESERVED.

Any and all information, including, among others, wordings, pictures, graphs are the properties of ThermTec Technology Co., Ltd. or its subsidiaries (hereinafter referred to be “ThermTec”). This user manual (hereinafter referred to be “the Manual”) cannot be reproduced, changed, translated, or distributed, partially or wholly, by any means, without the prior written permission of ThermTec. Unless otherwise stipulated, ThermTec does not make any warranties, guarantees or representations, express or implied, regarding to the Manual.

This Manual is applicable to Thermal Imaging scope.

The Manual includes instructions for using and managing the product. Pictures, charts, images and all other information hereinafter are for description and explanation only. The information contained in the Manual is subject to change, without notice, due to firmware updates or other reasons.

# Regulatory Information

These clauses apply only to the products bearing the corresponding mark or information.



This product and, if applicable, the supplied accessories are marked with “CE” and comply therefore with the applicable harmonized European standards listed under the Radio Equipment Directive 2014/53/EU, the EMC Directive 2014/30/EU, the RoHS Directive 2011/65/EU.



This product and - if applicable - the supplied accessories too are marked with “UKCA” and comply therefore with the following directives: Radio Equipment Regulations 2017, Electromagnetic Compatibility Regulations 2016, Electrical Equipment (Safety) Regulations 2016, the Restriction of the Use of Certain Hazardous Substances in Electrical and Electronic Equipment Regulations 2012.



This product and - if applicable - the supplied accessories too are marked with “RoHS” and comply therefore the requirements of Directive 2011/65/EU on the restriction of the use of certain hazardous substances in electrical and electronic equipment (“RoHS recast” or “RoHS 2”).



2012/19/EU (WEEE directive): Products marked with this symbol cannot be disposed of as unsorted municipal waste in the European Union. For proper recycling, return this product to your local supplier upon the purchase of equivalent new equipment, or dispose of it at designated collection points. For more information see: [www.recyclethis.info](http://www.recyclethis.info).



Directive 2006/66/EC and its amendment 2013/56/EU (Battery Directive): This product contains a battery that cannot be disposed of as unsorted municipal waste in the European Union. See the product documentation for specific battery information. The battery is marked with this symbol, which may include lettering to indicate cadmium (Cd), lead (Pb), or mercury (Hg). For proper recycling, return the battery to your supplier or to a designated collection point. For more information see: [www.recyclethis.info](http://www.recyclethis.info).

# 1 Introduction

## 1.1 Device Description

ARES & ARES LRF Series thermal imaging scope is equipped with  $12\mu\text{m}$  high-sensitivity detector with the resolution up to  $640\times 512$ , and adopts dual-field of view with the focal lengths of 20mm/60mm,  $1024\times 768$  high-definition OLED display, as well as AI/laser rangefinder, to get clear view under harsh environments for a long distance, even in poor visibility or total darkness. It helps to see through obstacles hindering the detection of targets, and measure the distances. The function of easy connection to phone enables users to share views in real time.

ARES & ARES LRF Series thermal imaging scope is designed for various areas of application including night hunting, observation, rescue operations, hiking and traveling, etc.

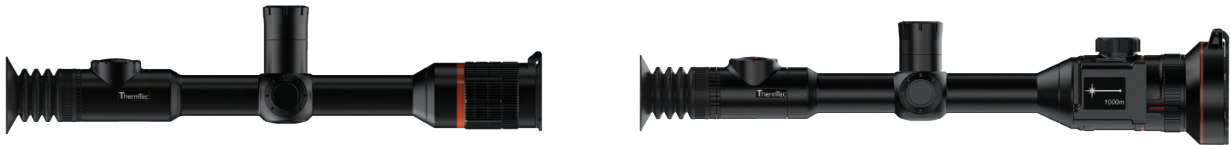



## 1.2 Features

### Dual FOV

Using the unique dual FOV and 3× optical zoom, the user can quickly shift the dual FOV manually. A wider FOV with a focal length of 20mm is used for target search while a narrower FOV with a focal length of 60mm for target identification.

### Auto Zeroing

It provides “First-Shot Auto-Zeroing” functionality, and stores up to 5 zeroing profiles for different guns while displaying zeroing coordinates, distances and type of guns, making it easy to switch guns without having to re-zero.

### Automatic Object Detection (Ares Only)

After the wireless network is connected, the scope detects the target and sends a notification through the APP automatically to ensure that the user will never miss an object entering his/her field of view.

### Non-Shutter Correction Technology

Invisible, background calibration means the screen will never freeze and there is no noisy shutter to alert your quarry.

### AI/Laser Rangefinder

The AI/laser rangefinder realizes a long range target measurement and an accurate shooting.

### Picture-in-Picture Function

In picture-in-picture mode, it displays a magnified image at the top-center of the overall field of view with aligned crosshairs and ½ mil FFP reticle when zooming on an object of interest.

### Recoil Activated Video (RAV)

With RAV, it records videos of before, during and after your shot, and captures the footage of your hunting moments.

## 1.3 Detection Range

The illustration below shows the comparative range performance of the device with different lens configurations. The data is based on detecting a car of 4m, a man of 1.8m tall, a wild boar of 0.7m tall, a wolf of 0.5m tall, a rabbit of 0.3m tall and a bird of 0.2m tall.

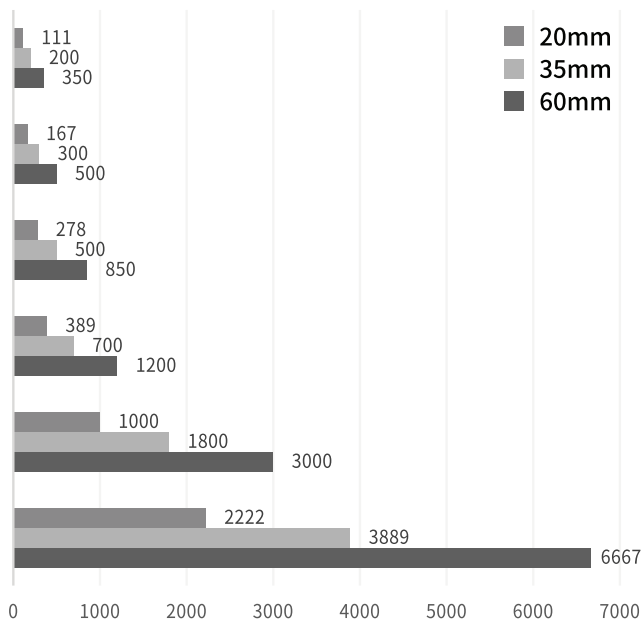

## 1.4 Cautions



### CAUTION



Avoid hard objects.



Do not aim the lens directly at the sun or high-temperature light sources.



Do not use the device in extremely cold or hot environment.



Charge the battery once every three months when it is not used for a long period of time.



Do not irradiate the laser indicator of the device to human eyes.



Do not disassemble or modify the device by yourself in any way.

## 2 Packing List - Ares

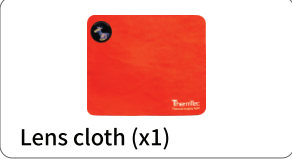
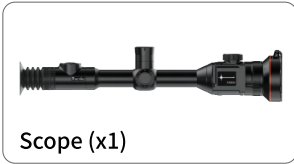

# Packing List - Ares LRF



Scope (x1)



30mm tube clip (x2)



18650 battery cap (x1)



Lithium battery (x2)



USB cable (x1)



Charger (x1)



Eyeshade (x1)



Lens cloth (x1)



18500 battery cap (x1)





# Specifications

## Ares

Model	ARES335	ARES360	ARES635	ARES660
<b>Microbolometer</b>				
Type	Uncooled			
Resolution	384x288			640x512
Pixel pitch	12µm			
NETD	≤35mk			
Spectral range	8-14µm			
Frame rate	50HZ			
<b>Optics</b>				
Objective lens	35mm, F1.0	20/60mm, F1.0	35mm, F1.0	20/60mm, F1.0
Field of view	7.5°x5.6°	13.1°x9.8°/ 4.4°x3.3°	12.5°x10.0°	21.7°x17.4° / 7.3°x5.9°
Magnification	3.2X	1.8X/5.5X	1.9X	1.1X/3.2X
Digital zoom	1.0-5.0X smooth & rapid zoom			
Eye relief	50mm			
Exit pupil	6mm			
Diopter	±5D			
<b>Aiming Reticle</b>				
Click range, m @100 m (H/V)	3.6m/3.6m			
Reticle	7			
Reticle color	Black and white			
<b>Display</b>				
Type	AMOLED			
Resolution	1024x768			
Display size	0.39 inch			
Color palette	6			

<b>Function</b>				
Max. recoil power on rifled weapon	6,000J			
Mounting brackets on weapon	Standard 30mm rings			
RAV	Yes			
Auto zeroing	Yes			
Manual zeroing	Yes			
Zeroing profiles	5			
Picture-in-picture	Yes			
AI ranging	Yes			
Image calibration	Via lens cover			
<b>Video Recorder</b>				
Phone/video playback	Yes			
Built-in memory	16GB			
<b>Interface</b>				
Type C	Data transfer			
Wi-Fi	Yes			
<b>Battery</b>				
Battery type	Replaceable, 18650 or 18500 battery			
Battery reverse connection	Yes			
Battery life	6h			
<b>Environment</b>				
Operating temperature	-20- +50°C			
IP rating	IP67			
Weight, g	797	1,142	797	1,142
Dimension, mm	397(L)x79(W) x94(H)	438(L)x8 4(W)x10 5(H)	397(L)x7 9(W)x94 (H)	438(L)x8 4(W)x10 5(H)
<b>Accessories</b>				
External cable	USB data cable			
Other accessories	2x standard 30mm rings, eyeshade and etc.			

# Specifications

## Ares LRF

Model	ARES335L	ARES360L	ARES635L	ARES660L
<b>Microbolometer</b>				
Type	Uncooled			
Resolution	384x288		640x512	
Pixel pitch	12µm			
NETD	≤25mk			
Spectral range	8-14µm			
Frame rate	50HZ			
<b>Optics</b>				
Objective lens	35mm, F1.0	20/60mm, F1.0	35mm, F1.0	20/60mm, F1.0
Field of view	7.5°x5.6°	13.1°x9.8°/ 4.4°x3.3°	12.5°x10.0°	21.7°x17.4°/ 7.3°x5.9°
Magnification	3.2X	1.8X/5.5X	1.9X	1.1X/3.2X
Digital zoom	1.0-5.0X smooth & rapid zoom			
Eye relief	50mm			
Exit pupil	6mm			
Diopeter	±5D			
<b>Aiming Reticle</b>				
Click range, m @100 m (H/V)	3.6m/3.6m			
Reticle	7			
Reticle color	Black and white			
<b>Display</b>				
Type	AMOLED			
Resolution	1024x768			
Display size	0.39 inch			
Color palette	6			

Function				
Max. recoil power on rifled weapon	6,000J			
Mounting brackets on weapon	Standard 30mm rings			
RAV	Yes			
Auto zeroing	Yes			
Manual zeroing	Yes			
Zeroing profiles	5			
Picture-in-picture	Yes			
Laser ranging	1,000m			
Image calibration	Via lens cover			
Video Recorder				
Phone/video playback	Yes			
Built-in memory	16GB			
Interface				
Type C	Data transfer			
Wi-Fi	Yes			
Battery				
Battery type	Replaceable, 18650 or 18500 battery			
Built-in Battery	5000mAh, rechargeable			
Battery life	12h			11h
Environment				
Operating temperature	-20- +50°C			
IP rating	IP67			
Weight, g	900	1,250	900	1,250
Dimension, mm	397(L)x79(W)x94(H)	438(L)x84(W)x105(H)	397(L)x79(W)x94(H)	438(L)x84(W)x105(H)
Accessories				
External cable	USB data cable			
Other accessories	2x standard 30mm rings, eyeshade and etc.			

# 4 Appearance

## 4.1 Dimensions

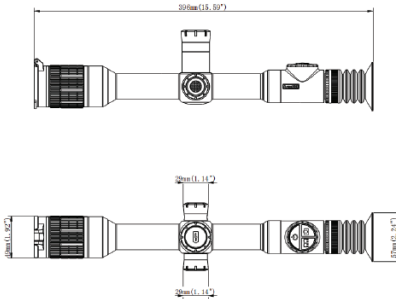

ARES 335/635

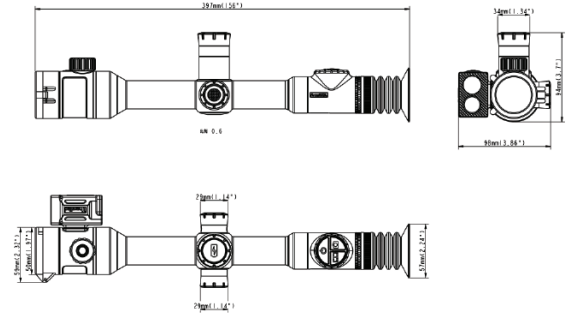

ARES 335L/635L

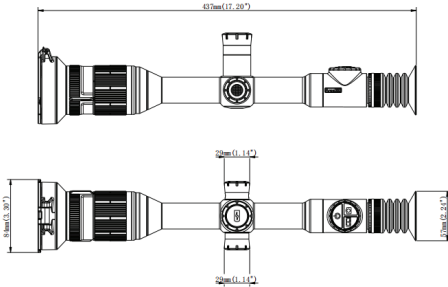

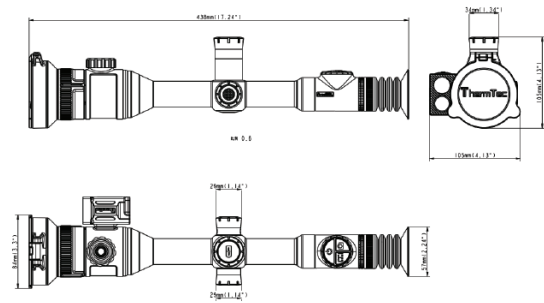
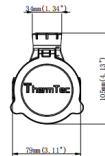

ARES 360/660



ARES 360L/660L

Notes: the size of battery cap marked in the drawings refers to 18650 battery cap, which can be replaced by 18500 battery cap.

## 4.2 Buttons and Controls

		Short Press	Long Press	Double Press
	Power ON/OFF	Enter standby mode and screen locked	ON/OFF	N/A
	AI/Laser Rangefinder	Color plates shift	AI/Laser rangefinder function on/off	Target outline mode on/off (Ares L only)
	Capture/Record	Take photos	Take videos	PIP on/off

 Rotary Knob	Before the entry of Main Menu			
	Rotate Knob	Short Press+Rotary Knob	Long Press	Double-Press
	Zooming	Brightness/contrast adjustment	Entry of main menu	Image calibration
	After the entry of Main Menu			
	Rotate Knob	Short Press	Long Press	Double-Press
Up/down selection	Confirm	Exit	N/A	

## Ares

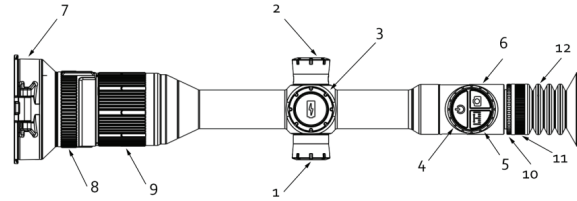

- 1 Rotary knob
- 2 USB
- 3 Battery slot
- 4 Power button
- 5 AI Rangefinder button
- 6 Capture/Record button
- 7 Objective Lens
- 8 Dual-FOV switch (for Ares360 and Ares660)
- 9 Objective lens focusing
- 10 Diopter adjustment
- 11 Eyepiece
- 12 Eyeshade



## Ares LRF

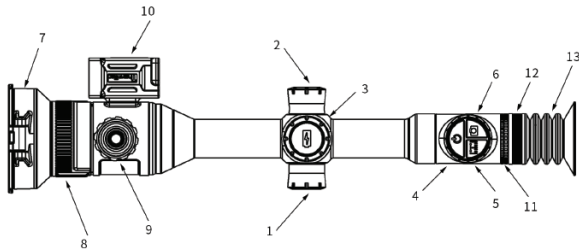

- 1 Rotary knob
- 2 USB
- 3 Battery slot
- 4 Power button
- 5 Laser rangefinder button
- 6 Capture/Record button
- 7 Objective Lens
- 8 Dual-FOV switch (for Ares360L and Ares660L)
- 9 Objective lens focusing
- 10 Laser rangefinder module
- 11 Diopter adjustment
- 12 Eyepiece
- 13 Eyeshade

## 5 Operation Guide

### 5.1 Battery Installation

#### Ares

The battery's anode and cathode can be installed interchangeably.

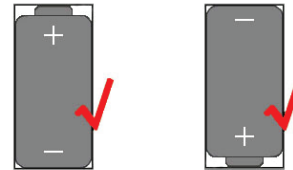

The battery icon indicates the electric quantity of the replaceable battery.

## Ares LRF

Please refer to the following figure for the installation of the replaceable battery (the positive pole should be installed inwards).

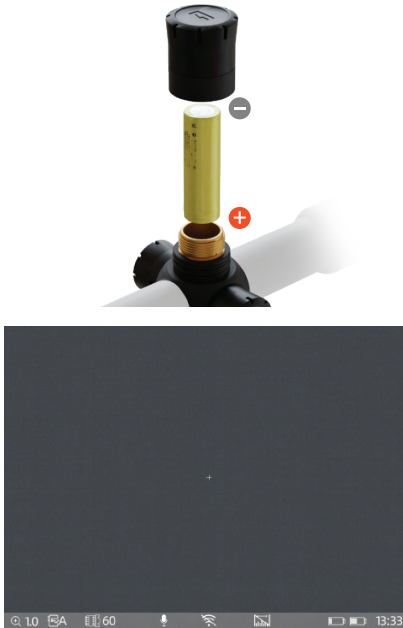

1 2

1. The battery icon at the left side indicates the electric quantity of the replaceable battery.
2. The battery icon at the right side indicates the electric quantity of the built-in battery.

## 5.2 Power-on the Device



Power button

## 5.3 Main Menu

Long press the middle of the rotary knob to enter the main menu. After the entry of Main Menu, short press the button for the operation of “Confirmation”, and long press the button for the operation of “Exit”. Rotating the knob is the operation of moving the cursor.



Main Menu

## 5.4 Lens Adjustment

### 5.4.1 Diopter Adjustment

Slowly rotate the diopter adjustment ring, and adjust the position of diopter level to optimize the image sharpness on the OLED display.



Rotate the diopter adjustment ring to adjust the position of diopter level.

### 5.4.2 Objective Lens Focusing

Manually adjust the objective lens focusing when necessary.

Focus on the target, and rotate the objective lens until it clicks into place.



Rotate the objective lens for focusing both clockwise or anticlockwise.

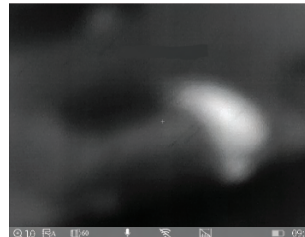

Focus on the selected target



Focusing finished

### 5.4.3 Digital Adjustment of Focus Distance

On the main screen, rotate the knob to digitally adjust the focus distance. Rotate upward for zooming in, and rotate the knob downward for zooming out.



Rotate upward for zooming in, and rotate the knob downward for zooming out.



### 5.4.4 FOV Selection and Shifting (for Ares360(L) and Ares660(L))

The device is set with dual-field of view. Rotate the lens to shift the field of view from 20° to 60° or from 60° to 20°.



Shift the FOV  
from 60° to 20°



FOV successfully  
shifted

## 5.5 Shortcut Menu

### 5.5.1 Taking photos/videos



Take photos-short press the Capture/Record button;  
Take videos - long press the Capture/Record button.

### 5.5.2 AI/Laser Ranging



Notes: AI ranging function is available for the models of Ares series, while laser ranging function is available for the models of Ares LRF series.

AI/Laser Rangefinder - long press the AI/Laser Rangefinder button to turn on/off the AI/laser rangefinder.

### 5.5.3 Pseudo Color Switch



Pseudo color switch - short press the button to switch the pseudo colors.

### 5.5.4 Target Outline Mode(Ares L Only)



Target outline mode - double press the button to turn on/off the Outline mode.

## 5.5.5 Standby Mode



Standby mode - short press the Power button

## 5.5.6 Contrast Adjustment



Short press the middle of the rotary knob to enter the Contrast screen.



The screen of Contrast Adjustment by clicking the shortcut button



Rotate the knob to increase or decrease the contrast degree.

## 5.5.7 Brightness Adjustment



Shortcut button: short press the rotary knob to enter the Brightness screen.



The screen of Brightness Adjustment by clicking the shortcut button



Rotate the knob to increase or decrease the brightness degree.

## 5.6 Entry of the Main Menu

Long press the middle of the rotary knob to enter the main menu. After the entry of Main Menu, short press the button for the operation of “Confirmation”, and long press the button for the operation of “Exit”. Rotating the knob is the operation of moving the cursor.

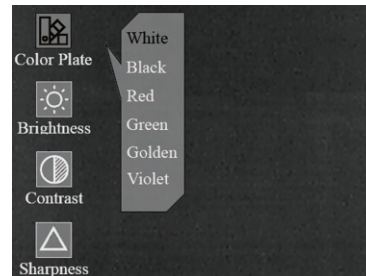

Color Plate

## Color Palettes



White



Black



Red



Green



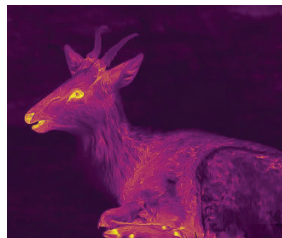

Golden



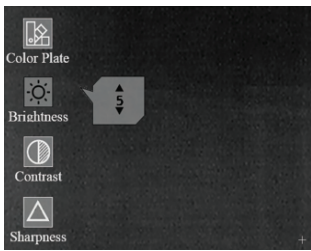

Violet

## 5.7 Image Settings

There are four sub-menus for image settings, which are “Brightness”, “Contrast”, “Sharpness” and “Denoise”. Short press the rotary knob to enter these sub-menus, and rotate the knob to adjust the images.



Image Setting Sub-menus	
<p><b>Brightness</b></p> 	<p>1-10 Adjust the image brightness to make the image brighter. The recommended value is 5.</p> 
<p><b>Contrast</b></p> 	<p>1-10 Adjust the image contrast to make the object more prominent in the image. The recommended value is 5.</p> 

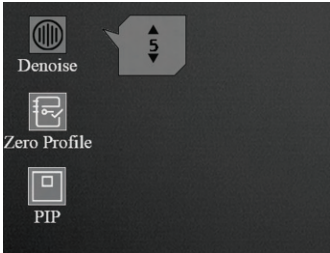





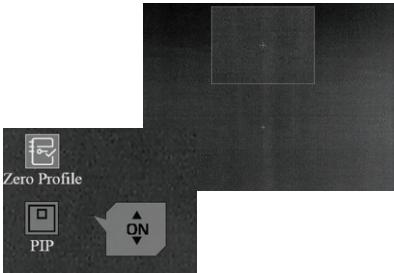

<p>Sharpness</p> 	<p>1-10</p>	<p>Adjust the image sharpness to make the edges of the image sharper. The recommended value is 5.</p> 
<p>Denoise</p> 	<p>0-10</p>	<p>Adjust the image noise to make the image cleaner. The recommended value is 5.</p> 

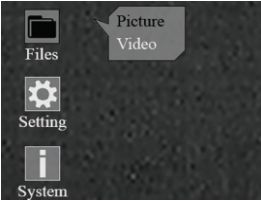
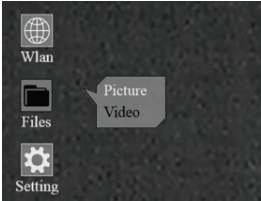

## 5.8 Settings

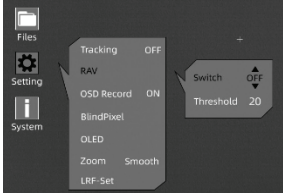

Short press the rotary knob to enter the sub-menus of Settings, and rotate the knob to adjust the parameters accordingly.

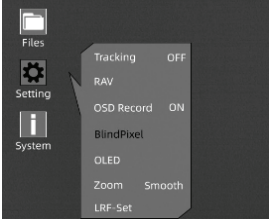
Sub-menus of Settings																															
<p>Zeroing profiles</p> 	<p>A-E There are five zeroing profiles from "A-E" in the file folder, which contain the distance, type of bullet, and the coordinates of the crosshairs after zeroing.</p> <table border="1" data-bbox="949 396 1259 575"> <tr> <td>A</td> <td>Distance</td> <td>m</td> <td>Gun</td> <td>X=</td> <td>Y=</td> </tr> <tr> <td>B</td> <td>Distance</td> <td>m</td> <td>Gun</td> <td>X=</td> <td>Y=</td> </tr> <tr> <td>C</td> <td>Distance</td> <td>m</td> <td>Gun</td> <td>X=</td> <td>Y=</td> </tr> <tr> <td>D</td> <td>Distance</td> <td>m</td> <td>Gun</td> <td>X=</td> <td>Y=</td> </tr> <tr> <td>E</td> <td>Distance</td> <td>m</td> <td>Gun</td> <td>X=</td> <td>Y=</td> </tr> </table>	A	Distance	m	Gun	X=	Y=	B	Distance	m	Gun	X=	Y=	C	Distance	m	Gun	X=	Y=	D	Distance	m	Gun	X=	Y=	E	Distance	m	Gun	X=	Y=
A	Distance	m	Gun	X=	Y=																										
B	Distance	m	Gun	X=	Y=																										
C	Distance	m	Gun	X=	Y=																										
D	Distance	m	Gun	X=	Y=																										
E	Distance	m	Gun	X=	Y=																										
<p>Picture-in-Picture</p> 	<p>The image is enlarged by 2x as centered by the crosshairs. Picture-in-picture occupies 10% of the entire image.</p> 																														

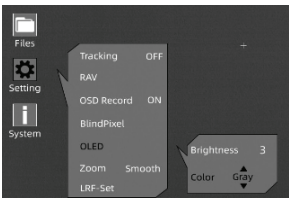
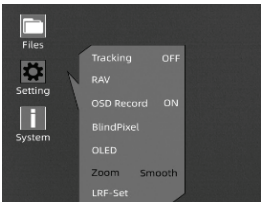
Files 	Picture	<p>Open the sub-menu of Picture, and rotary the knob to select the images.</p> 
	Video	<p>Open the sub-menu of Video, and rotary the knob to select the videos.</p> 
Setting 	Tracking	<p>Turn on heat tracking function to mark the hottest target on the screen in real time.</p> 

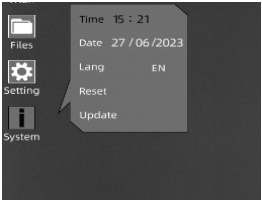
Setting 	RAV	<p>After turning on the RAV, the scope will record videos before, during and after your shot. The threshold can be modified manually for different weapons and ammunitions.</p> 
	OSD Record	<p>The menu on the screen will be recorded after turning on the OSD function.</p> 
	BlindPixel	<p>User can operate blind spot replaced function when pups up blindness.</p> 

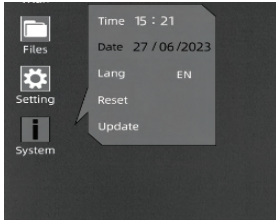
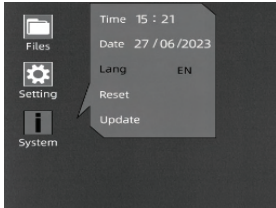
<b>Setting</b> 	<b>OLED</b>	<p>The color of OLED can be selected from red, blue, purple and gray.</p> 
	<b>Zoom</b>	<p>Smooth: The speed of zooming is more even.  Rapid: Integer zooming, suitable for fast moving target tracking.</p> 
<b>System</b> 	<b>Time</b>	<p>Adjust the local time manually.</p> 

<b>System</b> 	<b>Date</b>	<p>Adjust the local date manually.</p> 
	<b>Language</b>	<p>The language of the current system.</p> 
	<b>Reset</b>	<p>After resetting, the configuration parameters are restored to the factory state.</p> 

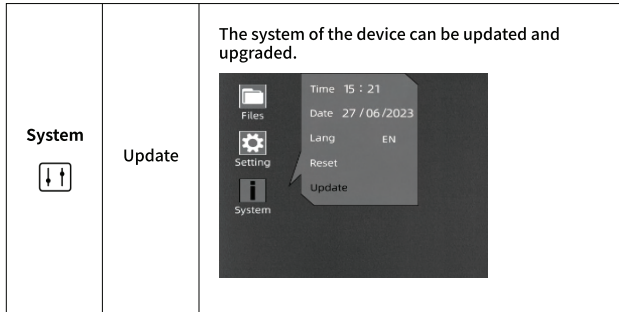

## 5.9 Zeroing

Enter the Main Menu, rotate the knob and short press the rotary knob to enter the sub-menu of Zeroing.

- ① Short press the rotary knob one more time. Rotate and short press the knob to select and confirm the zeroing distance (e.g. 25m or 35m).
- ② After that, move the cursor and short press the rotary knob to enter the Gun Type screen.
- ③ Rotate the knob anticlockwise until “+” appears.
- ④ Short press the rotary knob to add the Gun Type (customizable; press “Enter” on keyboard to add the Gun Type).
- ⑤ Rotate the knob clockwise and short press the rotary knob to select the Gun Type. Long press the rotary knob to return to the previous screen.

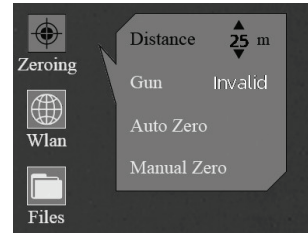

5.9 ①

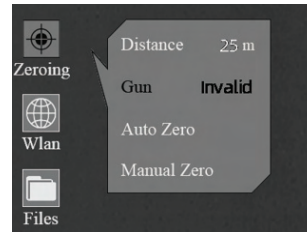

5.9 ②

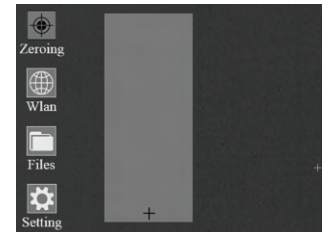

5.9 ③



5.9 ④

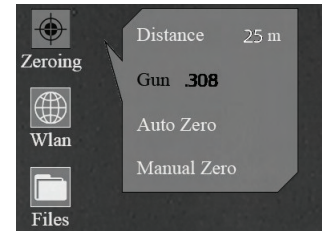

5.9 ⑤

## Notes:

1. Zeroing at a temperature close to the scope's operating temperature is recommended.
2. The FOV of 20mm and 60mm needs to be zeroed separately with the same method. The zeroing profile for FOV of 20mm and 60mm should be kept consistent.

### 5.9.1 Auto Zeroing

- ① Rotate the knob anticlockwise, and move the cursor to Auto Zero.
- ② Short press the rotary knob to enter the Auto Zeroing screen. Confirm the zeroing distance, and short press "OK" button to enter the next step.
- ③ When you are ready, press "OK" and finish the shooting within 15s.
- ④ Short press the rotary knob to save the zeroing data to any profile (A, B, C, D, E). Finally, long press the rotary knob to exit.

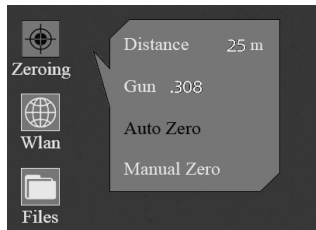

5.9.1 ①

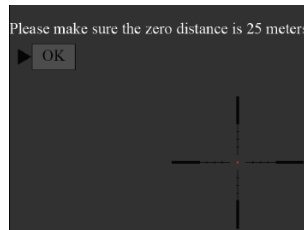

5.9.1 ②

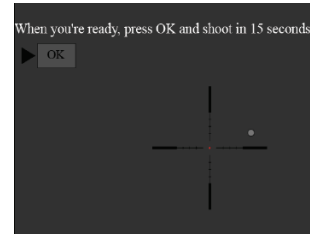

5.9.1 ③

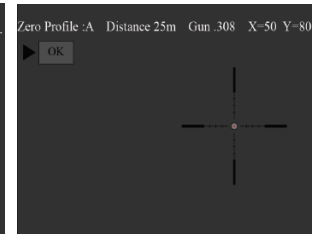

5.9.1 ④

### 5.9.2 Manual Zeroing

- ① Rotate the knob anticlockwise, and move the cursor to Manual Zero.
- ② Short press the rotary knob to enter the Manual Zeroing screen, confirm the zeroing distance, and short press "OK" to enter the next step.
- ③ After your first shooting is finished, align the reticle with point of aiming, and rotate the knob to turn on the Freeze function. ❄️ A screenshot will be taken. (The Freeze function allows you to freely move or manipulate the scope without losing reticle placement on the point of aim during adjustments.)
- ④ Rotate the knob to change the magnification  $\oplus$  when necessary, which helps to improve the accuracy of zeroing.

⑤ Adjust the coordinates (X, Y) of the reticle by rotating the knob, and move the reticle from the original position to the bullet hole position manually. (X and Y display values will change based on magnification after pressing Save button, e.g. X: -20mm (1x) will display -20mm, -10mm, -4mm in 1x, 2x, 5x respectively).

Short press the rotary knob to save the zeroing data to any profile (A, B, C, D, E). Finally, long press the rotary knob to exit.

## Notes:

1. The changes will always be saved based on your last calibration, e.g. the first saved coord is (-20mm, 35mm) in Profile A and you may want a tiny change like (-5mm, 5mm), so the device finally displays (-25mm, 40mm). If you put the same weapon name and the same distance, it takes data from the previous profile.

2. Please get back to the main menu to choose other profiles if you would like to save new data for another gun. It is suggested to save the subsequent changes where you first time saved for the same gun. It is not recommended to save a change in Profile A firstly then another change saved in Profile B or C.

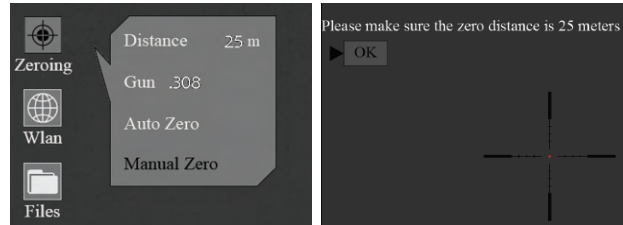

5.9.2 ①

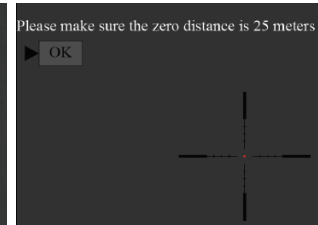

5.9.2 ②

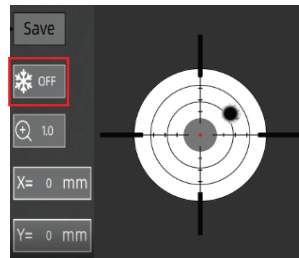

5.9.2 ③

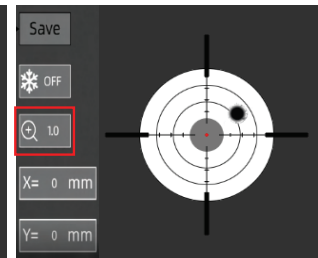

5.9.2 ④

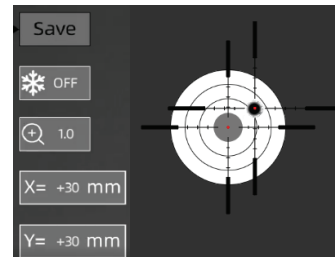

5.9.2 ⑤

## 5.10 Image Calibration (with Lens Cover Closed)

Taking advantage of the non-shutter correction technology, this device supports consistent view for shooting. In case that the sensor performance or the image quality need to be recovered or optimized, please follow below steps for image calibration.

Exit the main screen first, and then short press the rotary knob twice.

- ① A prompt will appear on the screen, reminding you to close the lens cover during image calibration.
- ② Click "OK" to start the process after closing the lens cover.

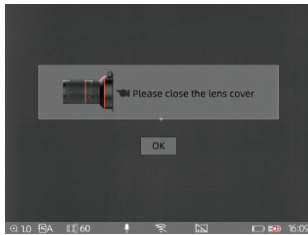





5.10 ①



5.10 ②

## 5.11 Reticles

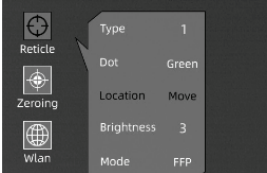
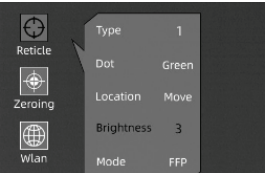
Type	1-7	<p>Rotate the knob to select the type of reticles. There are seven types of reticles set for selection.</p> 
Dot	3 Colors	<p>Rotate the knob to adjust the color of the Dot. There are three colors for selection, i.e. red, blue, and green.</p> 

<p><b>Location</b></p>	<p>Move/ Center</p>	<p>Rotate the knob to select the location of reticles. There are two options of "Move" and "Center" for selection.</p> <p>Move: Under 1x magnification, the location of the reticle keeps the same as the zeroing coordinates. The reticles will be returned to the center of the screen when image is zoomed in.</p> <p>Center: When zeroing is finished, the screen will be slightly enlarged based on the zeroing coordinates. The reticles will be returned to the center of the screen. When zoomed in/out, the reticle is always enlarged at the center of the screen.</p> 
<p><b>Brightness</b></p>	<p>3</p>	<p>Rotate the knob to select the brightness of reticles. There are three degrees of brightness set for selection.</p> 
<p><b>Mode</b></p>	<p>FFP/SFP</p>	<p>FFP: The reticle changes as the zoom in; SFP: The reticle doesn't change as the zoom in;</p> 

## 5.12 Blind Pixel

- ① Short press the rotary knob to enter the sub-menu of Blind Pixel.
- ② There are three options (cancel, save and replace). Replace: the blind pixel on the screen can be replaced. When finished, long press the middle of the rotary knob to exit.

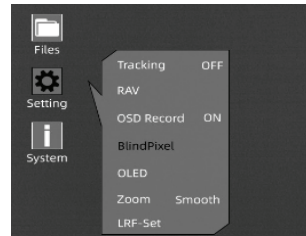

5.12 ①

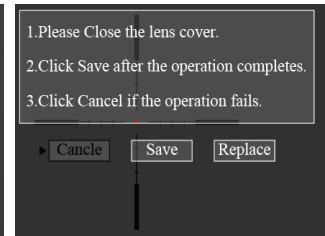

5.12 ②

## 5.13 Upgrade

- ① Connect the device to the computer, and drag the updating file to the file folder. The device should be connected all the time.
- ② Enter Settings menu, select Update, and the system will prompt "Program Updating".
- ③ When the update is finished, the device will automatically restart.



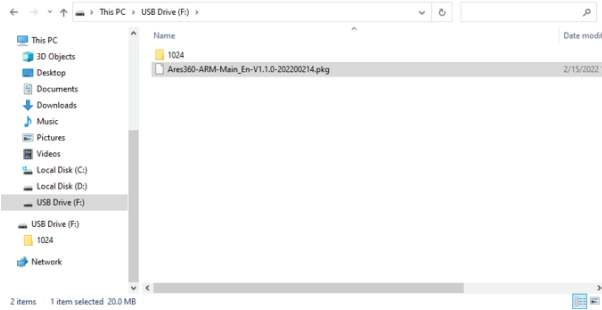

5.13 ①

## 6 APP Download

You can search "Smart Thermal" in Apple or Google Play APP Store to download our APP, or you can download it through the QR code shown on the packing box or user manual.

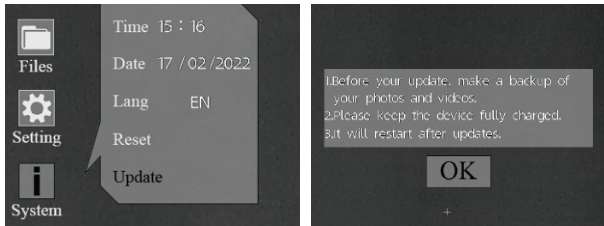

5.13 ②

5.13 ③

## 7 WIFI and Hotspot Settings

### 7.1 Connect via WIFI

Move the cursor to choose the icon of WLAN. You can select the sub-menus of Wi-Fi and Hotspot to make adjustments.

Steps are shown as below:

- ① Turn on personal hotspot on your phone;

② Enter the sub-menu of Wi-Fi, and the device will search for network Wi-Fi nearby. Choose the Wi-Fi to be connected, and enter the password to connect by rotating the knob. After it shows successful connection, you can open the mobile APP to view the images remotely.

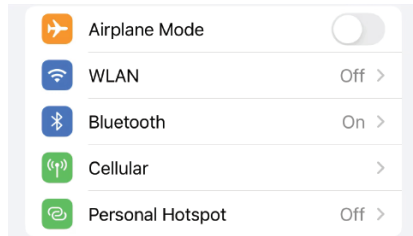

Turn on personal hotspot on your phone

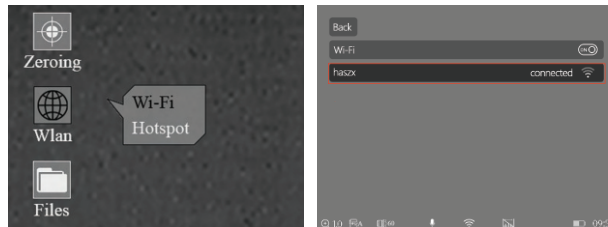

Successful WIFI Connection

## 7.2 Connect via Hotspot

Enter the sub-menu of Hotspot. One hotspot network will be released by the device. Set the hotspot name and password, and confirm by rotating the knob. Search the hotspot for connecting the device by phone, and open the phone APP to view the images remotely.

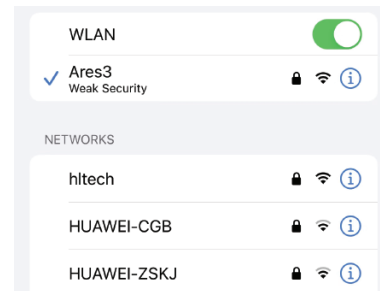

Connect the ARES Hotspot on your phone

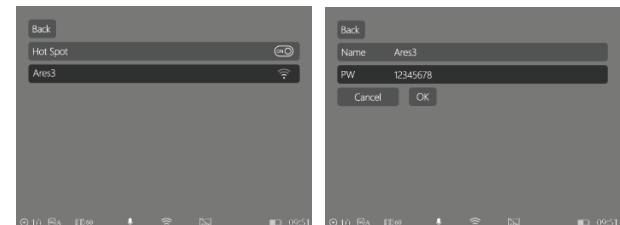

Successful WIFI Connection



# ThermTec

DISTRIBUTED BY  **SPIKA**

[contact@spika.com.au](mailto:contact@spika.com.au)

[www.spika.com.au](http://www.spika.com.au)

   SPIKA.TEAM

   ThermTec Outdoor